

Harmony

the soft closing hinge

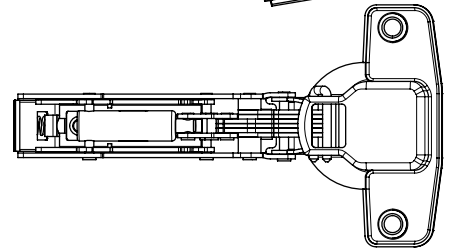

Harmony, the soft-closing hinge

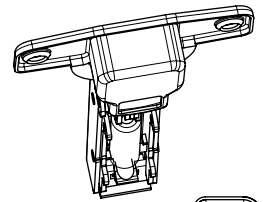
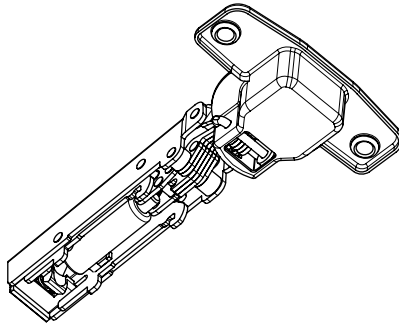
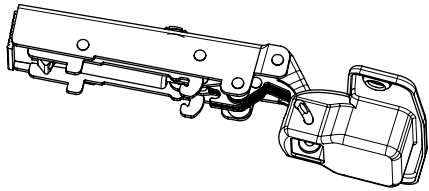
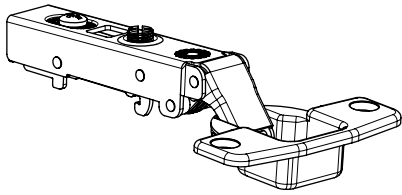

Harmony

- Different cranks and openings available (30, 45°, 90°, blind corner)
- Tested & approved by the Ferrari labs
- Guaranteed up to 50,000 cycles
- Quick fastening available
- Front and lateral cam adjustment plates available

The concealed soft closing solution

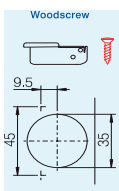
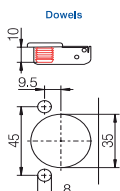
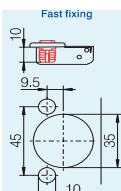
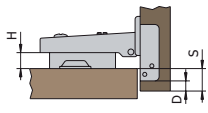
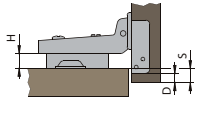
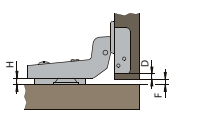
Drilling distance	45			48			52		
	Woodscrews	Dowels	Speed	Woodscrew	Dowel	Speed	Woodscrew	Dowel	Speed
Cup fastening									
D = Cup drilling distance									
S = Overlay									
F = Gap									
H = Plate Height									
Arm crank									
0									
Screw	EJ20079AGG	EJ20081AGG	EJ20619AGG	EJ20087AGG	EJ20091AGG	EJ20407AGG	EJ20095AGG	EJ20099AGG	EJ20551AGG
Cam	EJ25079AGG	EJ25081AGG	EJ25619AGG	EJ25087AGG	EJ25091AGG	EJ25407AGG	EJ25095AGG	EJ25099AGG	EJ25551AGG
									
H = 14 + D - S									
H	D	3	4	5	6	7			
0		17	18	19	20	21			
2		15	16	17	18	19			
4		13	14	15	16	17			
Arm crank									
8									
Screw	EJ20079BGG	EJ20081BGG	EJ20619BGG	EJ20087BGG	EJ20091BGG	EJ20407BGG	EJ20095BGG	EJ20099BGG	EJ20551BGG
Cam	EJ25079BGG	EJ25081BGG	EJ25619BGG	EJ25087BGG	EJ25091BGG	EJ25407BGG	EJ25095BGG	EJ25099BGG	EJ25551BGG
									
H = 4 + D - S									
H	D	3	4	5	6	7			
0		7	8	9	10	11			
2		5	6	7	8	9			
4		3	4	5	6	7			
Arm crank									
17									
Screw	EJ20079CGG	EJ20081CGG	EJ20619CGG	EJ20087CGG	EJ20091CGG	EJ20407CGG	EJ20095CGG	EJ20099CGG	EJ20551CGG
Cam	EJ25079CGG	EJ25081CGG	EJ25619CGG	EJ25087CGG	EJ25091CGG	EJ25407CGG	EJ25095CGG	EJ25099CGG	EJ25551CGG
									
H = -4 + D + F									
H	D	3	4	5	6	7			
0		1	0	-1	-2	-3			
2		3	2	1	0	-1			
4		5	4	3	2	1			

Harmony

Harmony, the special cranks

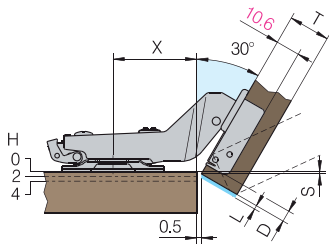

Harmony hinge
crank D (30°)
EJ20086DGG

	D	4	5	6	7	
H						
0		37	36	35	34	X
		4	4.9	5.8	6.7	S
2		37	36	35	34	X
		2	2.9	3.8	4.7	S
4		37	36	35	34	X
		0	0.9	1.8	2.7	S

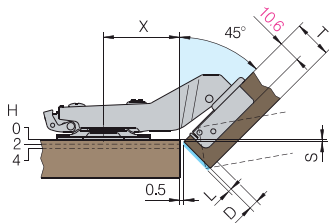

Harmony hinge
crank E (45°)
EJ20086EGG

	D	4	5	6	7	
H						
0		38	37	36	35	X
		2.5	3.4	4.3	5.2	S
2		38	37	36	35	X
		0.5	1.4	2.3	3.2	S
4		38	37	36	35	X
		-1.5	-0.6	0.3	1.2	S

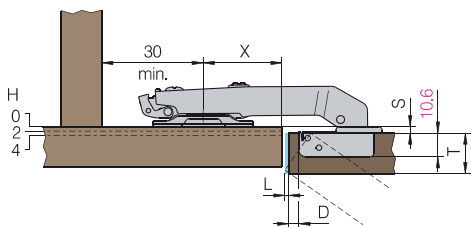

Blind corner
Harmony hinge
EJ20086IGG

	D	4	5	
H				
0		20	19	X
		1.5	1.5	S
2		20	19	X
		-0.5	-0.5	S
4		20	19	X
		-2.5	-2.5	S

Legend
D = Cup drilling distance
S = Overlay
F = Gap
H = Plate height
X = Plate fastening distance

Harmony

Plate fastening systems

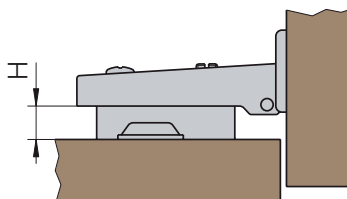

H = Height of mounting plates

37x32



H = 0
H = 2
H = 4

37x32

cam adj.







H = 0
H = 2
H = 4

10x32

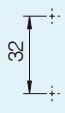
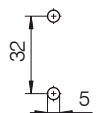
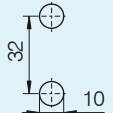
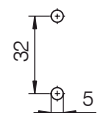

H = 0
H = 3

	 D.6.3x14	 Premounted	 Premounted	 Premounted
				
EJ20B1410MG00	EJ20B1002MG00	EJ20B1010MG00	EJ20B1282MG00	
EJ20B1410MG20	EJ20B1002MG20	EJ20B1010MG20	EJ20B1282MG20	
EJ20B1410MG40	EJ20B1002MG40	EJ20B1010MG40	EJ20B1282MG40	
EJ20B2150MG00	EJ20B2172MG00	EJ20B2160MG00	EJ20B2182MG00	
EJ20B2150MG20	EJ20B2172MG20	EJ20B2160MG20	EJ20B2182MG20	
EJ20B2150MG40	EJ20B2172MG40	EJ20B2160MG40	EJ20B2182MG40	
EJ20B0780MG00	EJ20B0792MG00			
EJ20B0780MG30	EJ20B0792MG30			

Number of hinges per door

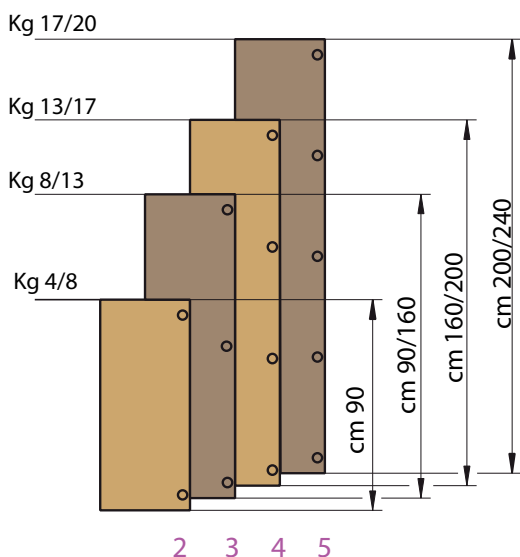

This chart should be used as a general guide for 600 mm wide doors. The hinge capacity may vary with different factors such as door material, thickness, size, etc. so the best solution is to perform empirical tests.

Available accessories

	
Cup cover	Arm cover
JCB03/GN	JCC90G-M



ITALY

Ferrari Point srl
Via E. Fermi, 4 - Loc. Olmi
I-31048 S. Biagio di Callalta (TV) - Italy
Tel.: +39 0422 892389
Fax: +39 0422 892296

AMERICA

Ferrari America Inc.
4189 Eagle Hill Driver Suite 110
27265 High Point - North Carolina USA
Tel.: +1 336 8411445
Fax: +1 336 8413543
Web: www.ferrariamerica.com
e-mail: info@ferrariamerica.com

CHINA

Ferrari Shunde R.O
New world China Land Shunde 15D
NO.148 Qinghui Road
Daliang Shunde 528308
FoShan China
Tel.: +86 757 22306761-2

GERMANY

Agostino Ferrari Germany GmbH
Im Meisenfeld 5
32602 Vlotho-Exter Germany
Tel. +49 522 896080
Fax. +49 522 8960824
www.ferrari-fittings.de
e-mail: ferrari@ferrari-fittings.de

UK

Euro-Fit Systems Ltd
Barmston Road - Beverley - East Yorkshire
HU17 0LA - United Kingdom
Tel.: +44 8071 296030
Fax: +44 8071 296040
Web: www.eurofitsystems.com
e-mail: info@eurofitsystems.com

SLOVAKIA

A. Ferrari Sk, s.r.o.
Levočská 3013/50
05801 Poprad Slovakia
Tel.: +421 52 7722105
Fax: +421 52 7793900



Copyright Ferrari. Subject to technical modifications and changes to the range without notice.

22ENG01
Printed in Italy

A. Ferrari S.p.A.

23878 Verderio Superiore (LC) - Italy
Via per Cornate, 45
Tel: +39 039 59 00
Fax: +39 039 590 022 2

www.ferrarispait
e-mail: ferrarispait@ferrarispait

